

STONE'S

J. Stone & Company, Ltd., Deptford, London

TRAIN LIGHTING EQUIPMENT

F E A T U R I N G

DUAL REGULATION

Leaflet Number
P. 1002



“LILIPUT” DUAL REGULATOR

Type L/T2

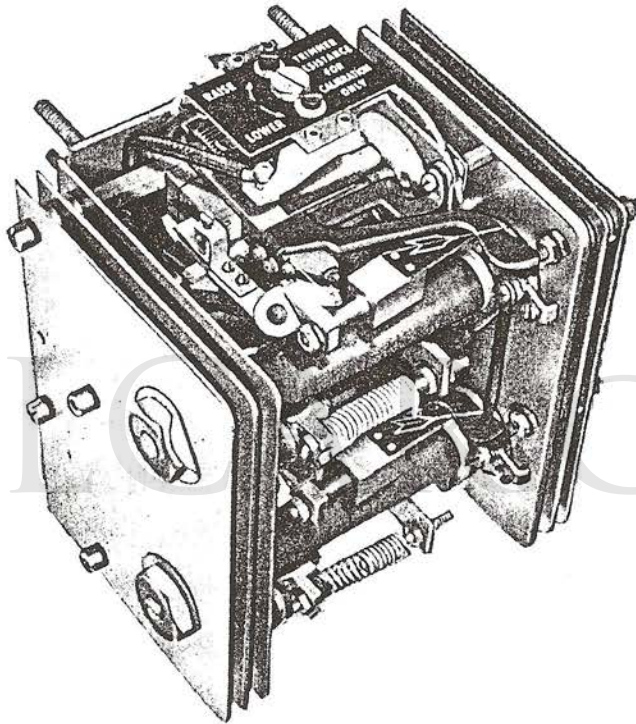

DISTINCTIVE FEATURES

- Compact design of self-contained unit construction.
- Special fin-cooling arrangement for Carbon Piles assuring maximum power rating.
- Contoured Armature Tongues of light weight and small movement, ensuring speed of response and precision in operation.
- Frictionless bearings, requiring no lubrication.
- Visual Resetting Indicator, enables the Regulator to be mechanically reset without the use of instruments.
- Exposed Carbon Pile, permitting easy inspection.
- Easy replacement of Carbon Piles.
- Frictionless diaphragm type damping device with no wearing parts, ensures Regulator Stability.
- A protective cover to discourage unauthorised interference.

continued overleaf

The "Liliput" Dual Regulator designed to provide complete automatic control of a wide range of shunt-wound generators, possesses the following outstanding advantages :—

ELECTRICAL FEATURES

- Full control is exercised over the whole speed range of the train.
- The full Generator output is available at all times, irrespective of the lights' "ON" or "OFF" condition.
- Lamp Voltage regulation within reasonable limits, is obtained without additional apparatus.
- Rapid battery recharge at **Constant Current** with tapered charge rate in the final stage at **Constant Voltage** — in strict accordance with the accumulator manufacturers' recommendations.
- All parts of the equipment are fully protected in the event of accidental break in the battery circuits.

GENERAL DESCRIPTION

The Regulator is of the automatic shunt field carbon pile type, comprising two separate magnet systems, each controlling its own carbon pile. The carbon piles are connected in series each with the other and the shunt field of the generator.

The current side is provided with a winding connected in series with the generator line, limiting the generator output to its maximum rating.

The voltage side is provided with a single shunt winding connected across the generator, to impose the ultimate constant voltage, and tapering charge, when the battery approaches the fully charged condition.

At the correct current or voltage, the magnet systems are in a state of balance for all positions of the armature, i.e., the systems will automatically set themselves to the pile resistance necessary to maintain constant current, or voltage.

Both magnet systems are identical, having two slots into which two armature tongues are attracted ; these tongues are mounted on " Y " shaped clappers which are carried on frictionless cross spring bearings. The control springs attached to the clapper effect pile compression and oppose magnet pull. Specially shaped tapered armatures ensure that the magnet pull varies linearly with armature movement. This enables the magnet characteristic to be readily matched by that of the control spring.

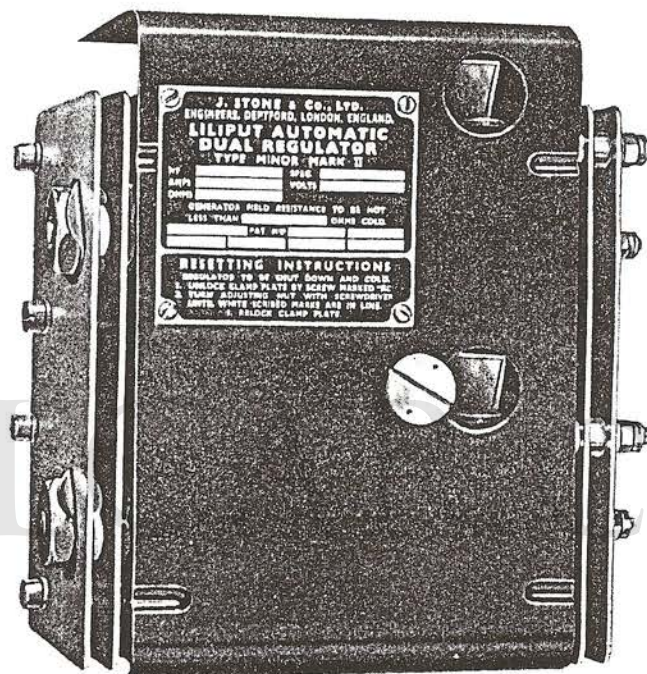

FRONT VIEW OF
"LILIPUT" REGULATOR
WITH PROTECTIVE COVER
IN POSITION

TEMPERATURE COMPENSATION

The Control Spring of the Voltage Regulator is mounted from a strip of bi-metal which, for the purpose of temperature compensation, is clamped to the magnet system. The bi-metal deflects to strengthen or weaken the spring according to the change of temperature.

DAMPING

The correcting force necessary to ensure stability is obtained by Air Compression Dashpots of the diaphragm type, which are carefully set at the time of manufacture, and require no further adjustment in service. The dashpot on the voltage magnet system is spring connected to give quick response.

continued overleaf

TRAIN LIGHTING SYSTEM

“LILIPUT” DUAL REGULATOR

Type L/T2

PILE RESETTING

It sometimes happens that a settling down process occurs (particularly in transit) in which Carbon Piles tend to shorten slightly. This contingency is catered for by a Pile Resetting Indicator. The necessity for adjustment is indicated by two white lines being out of alignment, and the correction is made by a screwdriver. These two lines are marked at the works when the regulator is set, and it is only necessary to observe occasionally their alignment and follow the simple re-setting instructions given on an engraved label mounted on the regulator cover. The white lines are clearly reflected in untarnishable mirrors observable through apertures in the cover.

CALIBRATION

At the top of the Regulator Unit is a small Voltage Adjusting Resistance (VAR), operated by a slotted screw. This adjustment is for use at the main depot ; its sole purpose is to re-establish the original setting by compensating any slight variation in voltage that may have taken place after lengthy service.

MAINTENANCE

The need for skilled attention during service has been reduced to a minimum ; maintenance in fact is largely confined to superficial examination for mechanical defects. Adjustments can be effected under stationary conditions without the use of special tools or electrical testing instruments.

MAINTENANCE IN SERVICE

REGULATOR TYPE L/T2

The regulator is a precision instrument and it is our earnest recommendation that no part of this apparatus should be interfered with unless the indications are that the service is not being maintained in the manner prescribed in the accompanying General Description of the system.

Reference to the panel and the wiring diagram will show that certain components are provided with a means of adjustment which materially affect the general performance of the equipment, and unauthorised readjustment of any of these components should be discouraged unless the need for readjustment is obvious and really necessary.

NOTE:- Before making any adjustments make sure the Battery is disconnected.

The following items have been made adjustable to suit known conditions at the time of installation :-

(1) The Generator Output Series Coil Diverter should be selected for the requisite generator output, which should not exceed the maker's rated output as given on the Generator nameplate.

(2) Voltage Selecting Resistances. Adjustable resistances are provided with access from the front of the panel, for the following adjustments to be made:-

(a) *Voltage Selector Resistances (VSR):-*

For selection of limiting voltage with lights "Off" to suit the type of battery.

(b) *Lamp Voltage Selector Resistances (LVS):-*

For selection of limiting voltage with lights "On".

(c) *Voltage Dividing Resistance (VDR):-*

This is provided with a link and 4 tapping points, in order that the most acceptable conditions of battery re-charge and lamp voltage regulation may be obtained. The link is positioned on the panel between the Resistances VSR and LVS. Position 1 will give the best lamp voltage regulation, while position 4 gives the best battery charging at all lamp loads. Positions 2 and 3 give intermediate results, position 2 being generally recommended.

(3) At the top of the Regulator Unit will be found a small Variable Resistance (VAR) operated by a slotted screw; this means of adjustment is provided for use at the main depot and solely for the purpose of re-establishing the original setting to compensate for any slight variation in voltage that may have taken place in the mechanism, as the result of a long period of service.

(4) On the back of the panel will be found a Voltage Calibrating Resistance (VCR) and this is made variable mainly to make the calibrated scale of the Voltage Selector Resistance (VSR) on the front of the panel coincide with the ultimate constant voltage actually obtained.

Pile Resetting

During storage and in the first few weeks of use, it sometimes happens that a "settling down" process occurs in which the pile tends to shorten slightly, and simple instructions are provided for this contingency in the form of an engraved label fitted on the regulator cover. After a short time, the pile should settle down and the necessity for this adjustment should become less frequent.

To Reset (See Fig.2)

(Maintenance Tools (See Fig.1))

Regulator to be shut down and cold.

- (1) *Unlock Clamp Plate by Screw Marked RD.*
- (2) *Turn Adjusting Nut with Screwdriver until white scribe marks are in line.*
- (3) *Relock Clamp Plate.*

This adjustment moves the pile adjusting screw referred to in the description.

Pile Examination and Replacement

From time to time the pile should be examined by running the finger nail along the surface. If the pile is in a good condition, it will appear to have a feeling of gritty hardness; if, however, the carbon rings appear to be soft so that the nail will sink in with ease, they should be replaced by a new set of elements.

To Replace the Carbon Pile :-

- (1) Disconnect the battery.
- (2) Remove the six 2BA nuts from the studs which secure the right-hand fin assembly.
- (3) Remove the right-hand fin assembly by drawing it off the mounting studs.
- (4) Slide the damaged carbons off their insulating tube.
- (5) Take a spare pile assembly and remove the cap securing the rings.
- (6) Apply the spare pile assembly so that the end of the rod holding the rings slips on to the end of the copper core of the pile mounting of the regulator (see Fig.3).
- (7) Slide the new rings on to the regulator pile mounting (see Fig.3).
- (8) Check that the overall length of these rings when held firmly is as near as possible 80 mm. (3.15 ins.).
- (9) Replace the fin assembly, with washers and nuts, and tighten nuts.
- (10) Reconnect battery.
- (11) Reset the regulator so that the scribe marks are in line (see Fig.2).

NOTE:- It is of the utmost importance that spare carbon rings should be of the correct grade and size. Replacements are supplied in containers holding a few more rings than are actually required, and it is necessary to discard only sufficient rings to ensure pile resetting in accordance with the instructions given under this heading.

When ordering spares the Specification Number of the regulator should be quoted and the makers cannot guarantee the performance of the regulator if carbon pile replacements are obtained elsewhere.

Damping

The necessary correcting force to ensure stability is obtained by the incorporation of the air compression diaphragm type dashpot which will have been carefully set by the manufacturers, and no attempt should be made to effect further adjustment. In the event of obvious instability or "hunting" in the regulator movement, the dashpot may

3 a 4

DM/3

have sustained mechanical damage, in which event a complete and adjusted dashpot should be obtained and substituted. (See Fig.10).

Do not tamper with the Air Control Screw as the Air Valve has been adjusted ready for use before leaving the manufacturers. (This applies only to the original dashpot with screw adjusted needle valve).

RAILCAR.CO.UK

OVERHAUL IN SHOPS

Periodical Examination of Dashpots
(Liliput Minor Regulator)

First Shopping (2 years)

- (1) Move the clapper by hand, until the magnet armature is right home, then release and note the time required for the dashpot plunger to return to the initial position. If the time is more than three seconds, there is foreign matter in the valve, which should be cleaned with the wire cleaner provided in the tool kit (see Fig.4).

If the time is less than three seconds, proceed as follows :-

- (2) Move the clapper by hand as in (1), and then, covering the capillary valve orifice with a piece of rubber tubing of suitable size, (pinched to seal it off) or with the tool provided, again note the time required to return (see Fig.5). If this time is less than seven seconds, the dashpot is leaking, and should be replaced.

NOTE: On certain early regulators, which have needle type dashpot valves, it is necessary to remove the right-hand set of fins to obtain access to the valve orifice, which may be closed by covering with the finger.

Second Shopping (4 years)

- (1) Repeat tests (1) and (2) under "First Shopping" (above).
- (2) Remove the dashpot from the regulator, as described below and examine the rubber diaphragm where it is exposed between the plunger and the casing. If there are any signs of cracking or hardening, the dashpot should be replaced. If the rubber is of good appearance and soft to the touch, the dashpot may safely be returned to service for a further period of two years, after which the four year check should again be carried out.

CAUTION: - Oil and grease will cause rubber to deteriorate rapidly, so care must be taken when examining the diaphragm that it is not allowed to come into contact with either of these.

To Remove the Dashpot

- (1) Disconnect battery.
- (2) Remove the 2BA nuts from the studs which secure the right-hand fin assembly
- (3) Remove the right-hand fin assembly by drawing it off the mounting studs.
- (4) Slacken captive screw which links dashpot compression plate with operating rod.
- (5) Release the three 6BA hexagonal pillar nuts and Thackeray washers fixing dashpot to regulator frame and withdraw dashpot.
- (6) Do not remove or tamper with the packing washers between the dashpot and its supporting frame. The correct number are fitted by the manufacturer.

To fit a new Dashpot

- (1) Take a new dashpot from container and place dashpot on fixing studs so that captive screw lines up with the hole in operating rod. Move clapper by hand to line up dashpot operating rod with hole in bush on dashpot compression plate, then push dashpot home (see Fig.6).

- (2) Replace the three 6BA hexagonal pillar nuts and Thackeray washers and tighten (see Fig.6).
- (3) Move the clapper by hand all the way in, then tighten the captive screw (see Fig.6).
- (4) Replace the fin assembly and tighten nuts (see Fig.2).
- (5) The carbon pile should now be reset, if necessary, in accordance with the instructions given under the heading "Pile Resetting" (see Fig.2).

Note:- At the conclusion of these operations do not forget to reconnect the battery.

Carbon Pile Support Rods

Under certain circumstances it is necessary to remove the heat dissipating fin assembly on the right-hand side of the regulator. This operation is necessary when a carbon pile has to be replaced or in the event of mechanical damage to the refractory tube surrounding the copper rod.

At the end of these rods it will be noticed that the cooling fin assembly is secured by two 2BA nuts. It will be realised that to ensure a good heat transference from the rod to the fin assembly, a good thermal conductor such as copper is essential. Consequently, when tightening up the nuts after replacing the fin assembly, only such force should be used as will ensure intimacy of good contact between the tapered end of the rod and the conical recess in the fin assembly. Do not employ as much force as could be used with safety if the assembly were steel.

This operation is best effected by the use of a very short spanner. A large spanner with greater leverage requires more care to avoid wrenching off or spoiling the threaded end.

Carbon Pile Support Rod Replacement.

In the event of mechanical damage occurring to the carbon pile support rod a certain amount of dismantling of the regulator and, in particular, the carbon pile assembly will be necessary. Both sides of the regulator must be accessible.

The sequence of operation is as follows :-

- (1) Disconnect the battery.
- (2) Remove the six 2BA nuts from the studs which secure the right-hand fin assembly.
- (3) Remove the right-hand fin assembly by drawing it off the conical ends of the mounting studs.
- (4) Slide the carbons off the refractory insulating tubes and store in a safe place, such as a spare pile container.
- (5) On the left-hand side of fins, remove the four 2BA round nuts and lock-washers. The left-hand fins can then be withdrawn with the pile rods. (See Fig.7).
- (6) The left-hand fin and pile rod assembly may then be dismantled. There is no necessity to remove both rods from the inside fin if only one is damaged. (See Fig.8).
- (7) Assemble the rod(s) into the inside fin, and replace on the regulator. The other fins with their distance pieces and nuts may then be assembled on the studs. (See Fig.9).
- (8) Turn up the edges of the locking-washers on the last pile rod nuts.

- (9) Replace the piles and right-hand set of fins.
- (10) Reset the regulator so that the scribe marks are in line. (See Fig.2).
- (11) Reconnect the battery.

RAILCAR.CO.UK

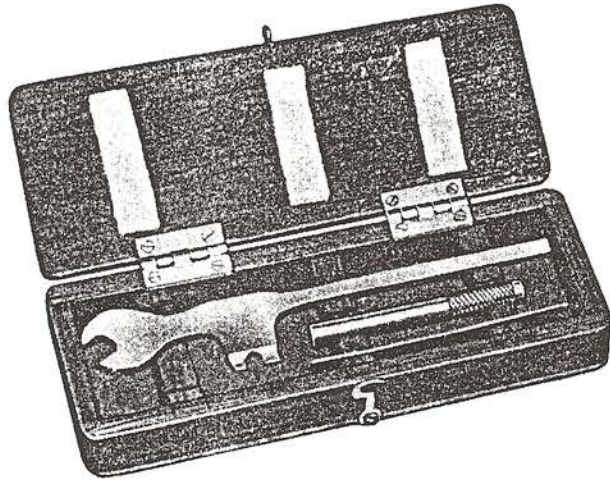

FIG. 1

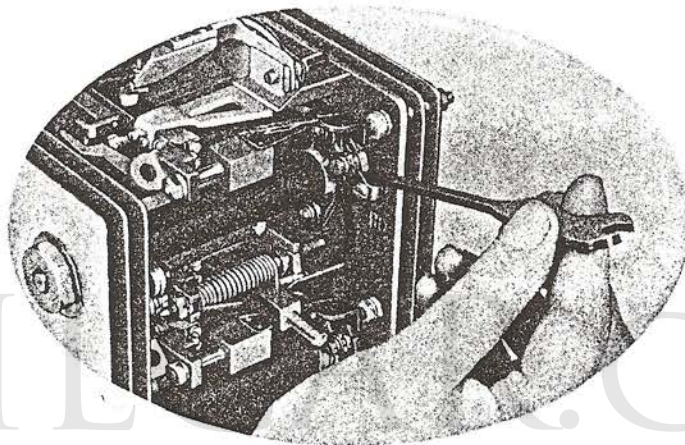

FIG. 2

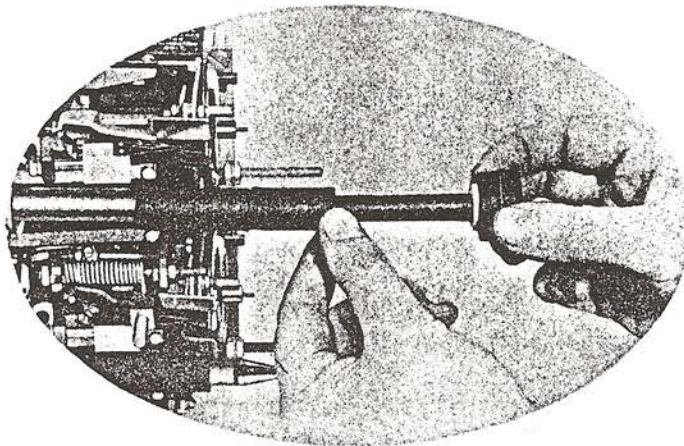

FIG. 3

LILIPUT DUAL REGULATOR TYPE L/T2	SECTION 3A
J. STONE & COMPANY (DEPTFORD) LTD	FIG. N° 1-3

3a 8

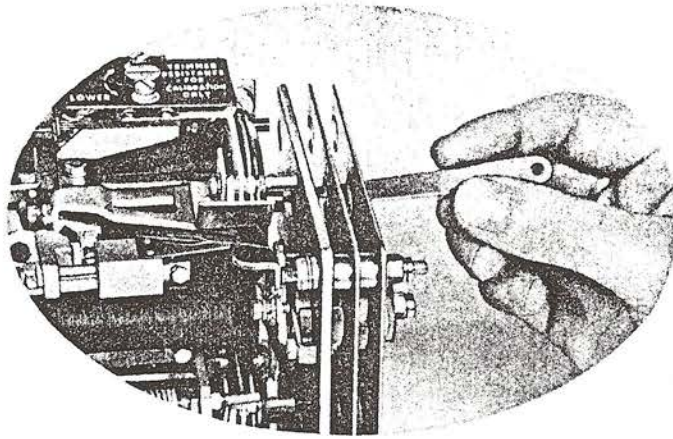

FIG. 4

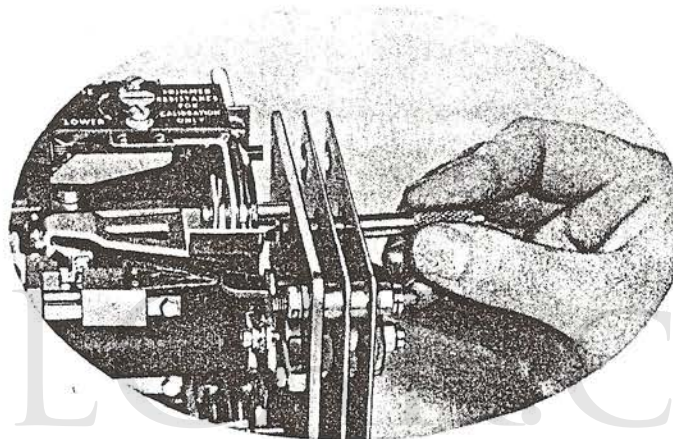

FIG. 5

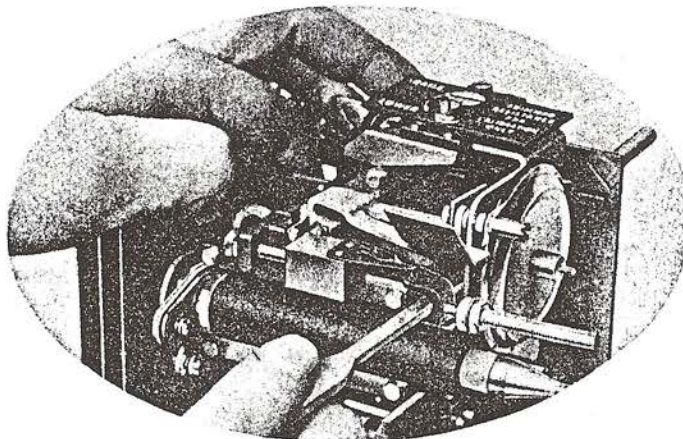

FIG. 6

LILIFUT DUAL REGULATOR TYPE L/T2

SECTION 3A

J. STONE & COMPANY (DEPTFORD) LTD

FIG. N^o 4-6

3a 9

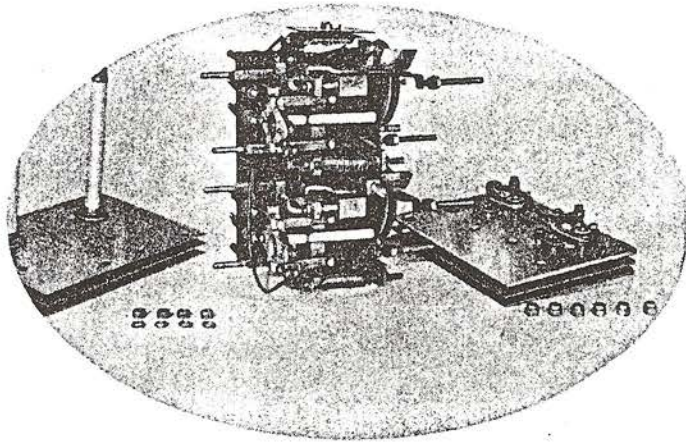

FIG.7

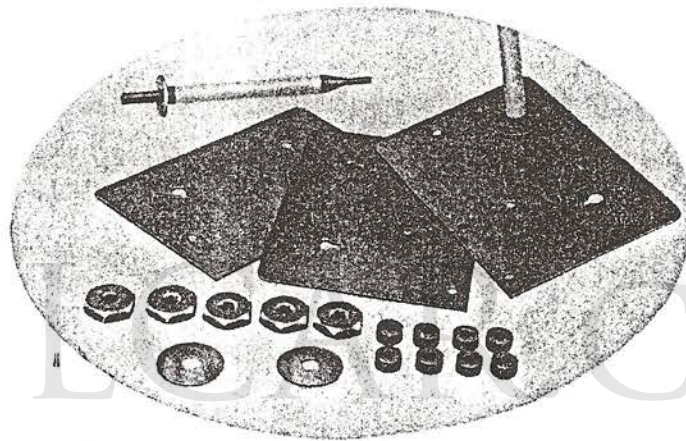

FIG.8

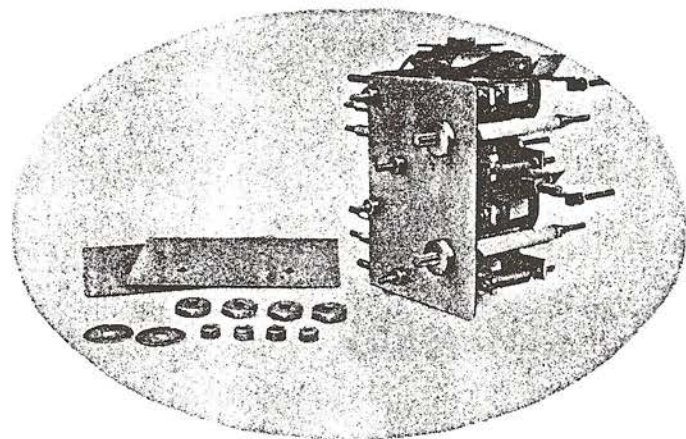
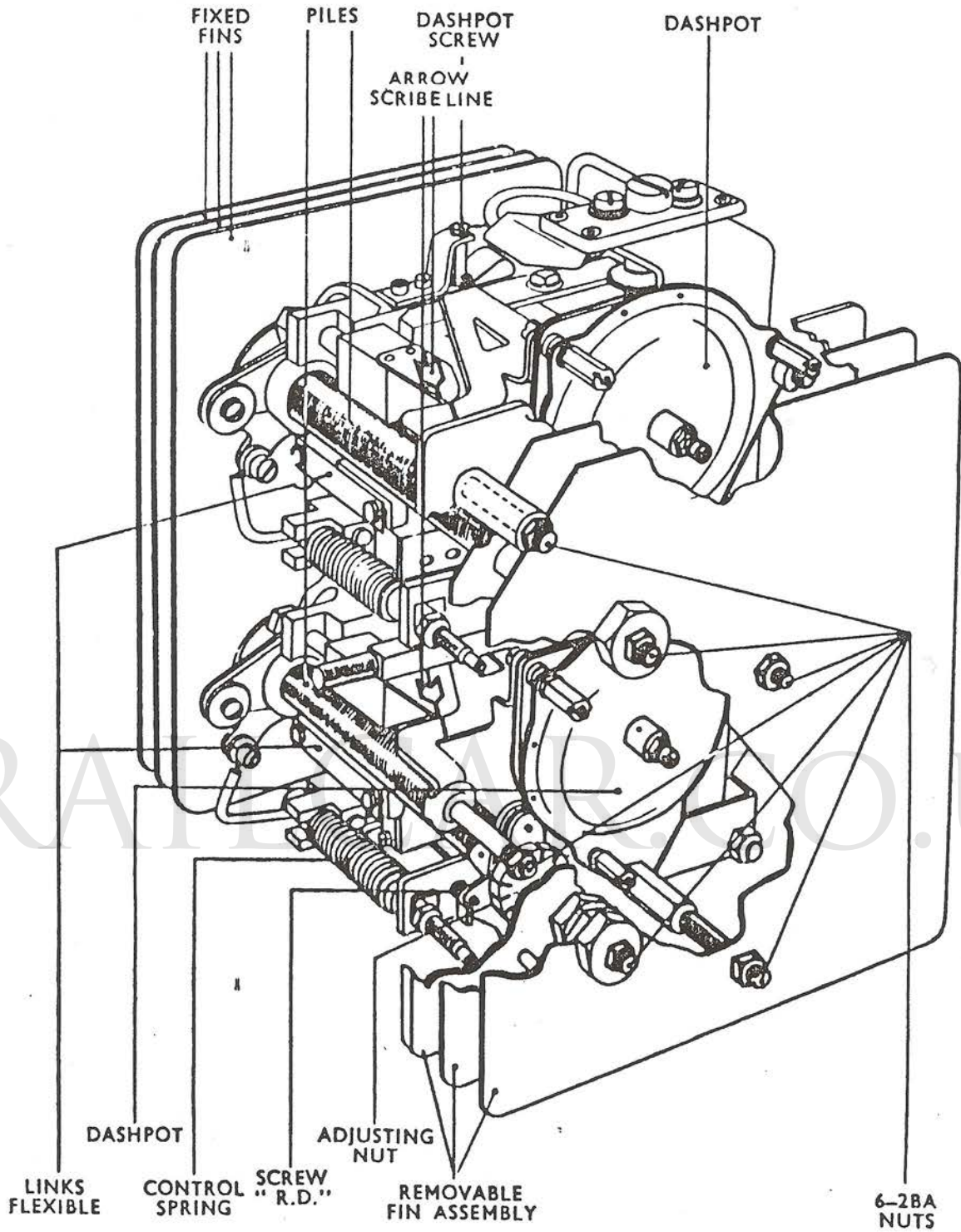

FIG.9

LILIPUT DUAL REGULATOR TYPE L/T2	SECTION 3A
J. STONE & COMPANY (DEPTFORD) LTD	FIG. N° 7-9



LILIPUT DUAL REGULATOR
TYPE L/T2

J. STONE & COMPANY (DEPTFORD) LTD

SECTION 3A

FIG. N° 10